

FURURA LIGHTING

RIBBON | 2008-09

“THINKING GREEN”

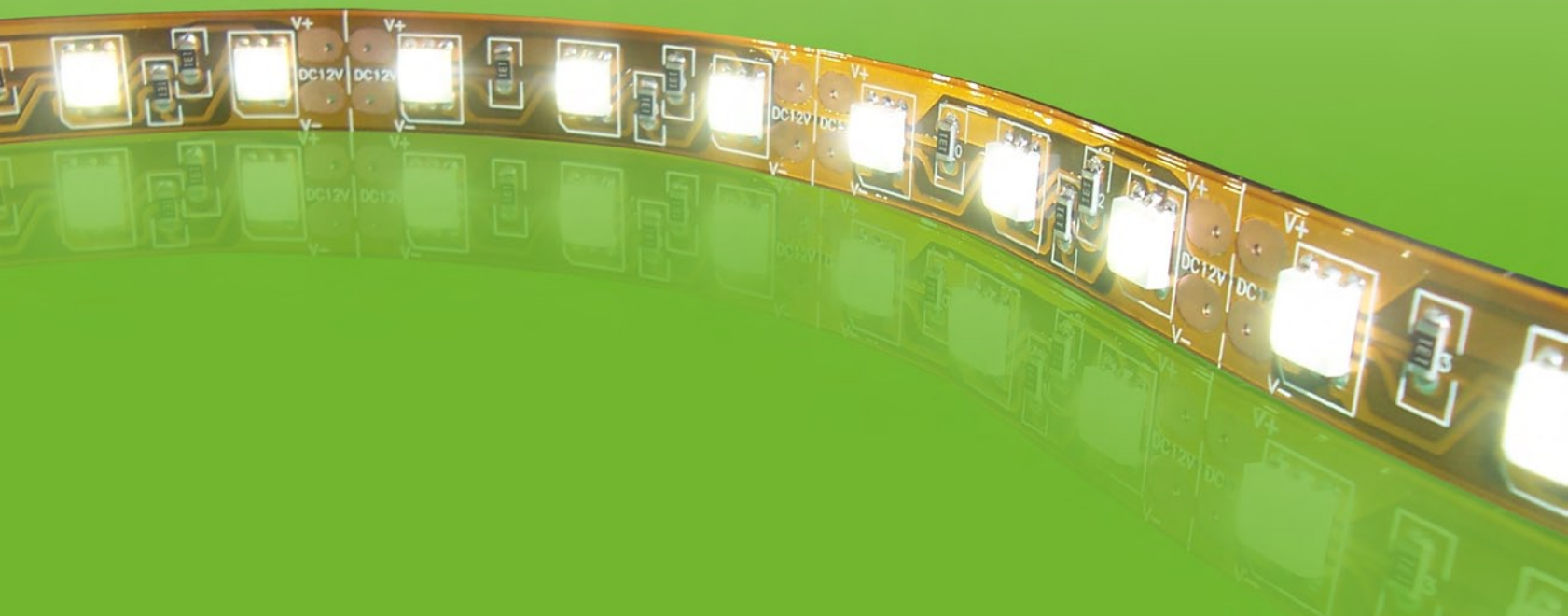

Flexible Ribbon LED Strip

Prod. Name: Flexible Ribbon LED Strip (Non-Waterproof)

Ref. Name: FL-RBL-WW (Warm White), FL-RBL-PW (Cool White)
 FL-RBL-RGB (Colors Change), FL-RBL-BL (Blue)
 FL-RBL-RD (Red), FL-RBL-AM (Amber)
 FL-RBL-GR (Green)

Dimensions:

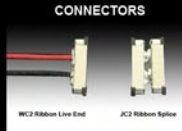
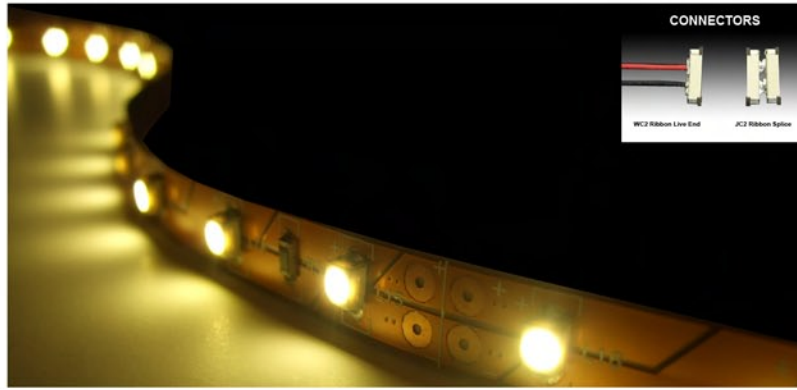
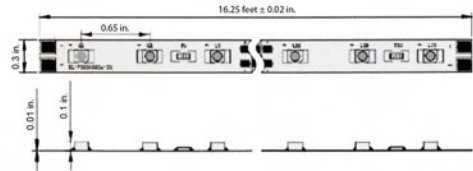

Technical Parameters:

LED Light Source	3528 SMD LED
Standard	300 LEDs per roll (16.25 feet)
Beam Angle	120 degrees
Working Voltage	12V DC
Working Current	400mA per meter (3.28 feet)
Power Consumption	1.50 watts per foot (24 watts per roll)
Light Output Per Roll	W: 600lm, R: 450lm, G: 500lm, BL: 300lm, AM: 450lm
Package	16.25 feet per roll (5 meters)
Connectors	WC 2 / JC 2
Connectors RGB	WC 4 / JC 4

Flexible Ribbon High Brightness LED Strip

Prod. Name: Flexible Ribbon High Brightness LED Strip (Non-Waterproof)

Ref. Name: FL-RBL-HB-WW (Warm White), FL-RBL-HB-PW (Cool White)
 FL-RBL-HB-RGB (Colors Change), FL-RBL-HB-BL (Blue)
 FL-RBL-HB-RD (Red), FL-RBL-HB-AM (Amber)
 FL-RBL-HB-GR (Green)

Dimensions:

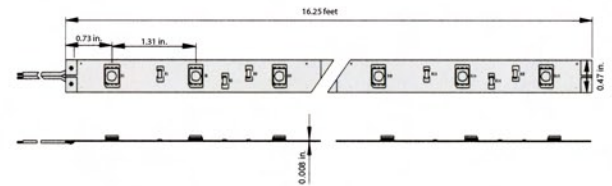

Technical Parameters:

LED Light Source	0.3W 5060 SMD LED
Standard	150 LEDs per roll (16.25 feet)
Beam Angle	120 degrees
Working Voltage	12V DC
Working Current	600mA per meter (3.28 feet)
Power Consumption	2.50 watts per foot (40 watts per roll)
Light Output Per Roll	W: 1800lm, R: 1300lm, G: 1500lm, BL: 900lm
Package	16.25 feet per roll (5 meters)
Connectors	WC-2-HB-CONN / JC-2-HB-CONN
Connectors RGB	WC-4-HB-CONN / JC-4-HB-CONN

Flexible Ribbon Ultra High Brightness LED Strip

Prod. Name: Flexible Ribbon Ultra High Brightness LED Strip (Non-Waterproof)

Ref. Name: FL-RBL-UHB-WW (Warm White), FL-RBL-UHB-PW (Cool White)
 FL-RBL-UHB-RGB (Colors Change), FL-RBL-UHB-BL (Blue)
 FL-RBL-UHB-RD (Red), FL-RBL-UHB-AM (Amber)
 FL-RBL-UHB-GR (Green)

Dimensions:

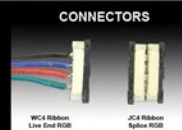
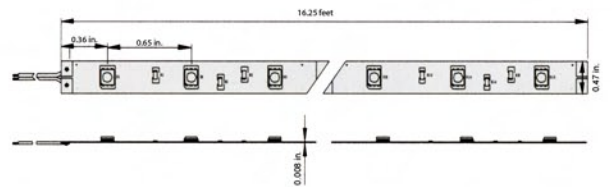

Technical Parameters:

LED Light Source	0.3W 5060 SMD LED
Standard	300 LEDs per roll (16.25 feet)
Beam Angle	120 degrees
Working Voltage	12V DC
Working Current	1.2A per meter (3.28 feet)
Power Consumption	5 watts per foot (80 watts per roll)
Light Output Per Roll	W: 3900lm
Package	16.25 feet per roll (5 meters)
Connectors	WC-2-HB-CONN / JC-2-HB-CONN
Connectors RGB	WC-4-HB-CONN / JC-4-HB-CONN

Flexible Ribbon Sideview LED Strip

Prod. Name: Flexible Ribbon Sideview LED Strip (Non-Waterproof)

Ref. Name: SI-RBL-WW (Warm White), SI-RBL-WP (Cool White)
SI-RBL-BL (Blue), SI-RBL-GR (Green)
SI-RBL-PURP (Purple), SI-RBL-RD (Red)
SI-RBL-YL (Yellow)

Dimensions:



Technical Parameters:

LED Light Source	3010 Sideview SMD LED
Standard	300 LEDs per roll (16.25 feet)
Beam Angle	120 degrees
Working Voltage	12V DC
Working Current	400mA per meter (3.28 feet)
Power Consumption	1.50 watts per foot (24 watts per roll)
Light Output Per Roll	W: 600lm, R: 450lm, G: 500lm, BL: 300lm, AM: 450lm
Package	16.25 feet per roll (5 meters)

Waterproof Flexible Ribbon LED Strip

Prod. Name: Waterproof Flexible Ribbon LED Strip (IP67)

Ref. Name: FL-STRIP-WW (Warm White), FL-STRIP-PW (Cool White)
FL-STRIP-RGB (Colors Change), FL-STRIP-BL (Blue)
FL-STRIP-RD (Red), FL-STRIP-AM (Amber)
FL-STRIP-GR (Green)

Dimensions:

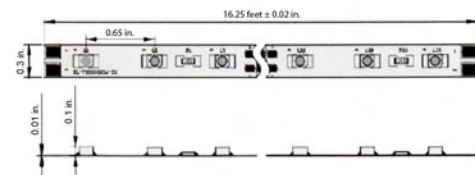

Technical Parameters:

LED Light Source	3528 SMD LED
Standard	300 LEDs per roll (16.25 feet)
Beam Angle	120 degrees
Working Voltage	12V DC
Working Current	400mA per meter (3.28 feet)
Power Consumption	1.50 watts per foot (24 watts per roll)
Light Output Per Roll	W: 1350lm, R: 800lm, G: 900lm, BL: 600lm, AM: 550lm
Package	16.25 feet per roll (5 meters)

UHB Waterproof Flexible Ribbon LED Strip

Prod. Name: UHB Waterproof Flexible Ribbon LED Strip (IP67)

Ref. Name: FL-STRIP-UHB-WW (Warm White), FL-STRIP-UHB-PW (Cool White)
FL-STRIP-UHB-RGB (Colors Change), FL-STRIP-UHB-BL (Blue)
FL-STRIP-UHB-RD (Red), FL-STRIP-UHB-AM (Amber)
FL-STRIP-UHB-GR (Green)

Dimensions:

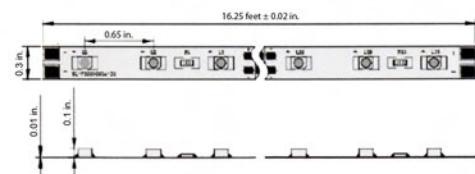

Technical Parameters:

LED Light Source	5060 SMD LED
Standard	300 LEDs per roll (16.25 feet)
Beam Angle	120 degrees
Working Voltage	12V DC
Working Current	400mA per meter (3.28 feet)
Power Consumption	5.0 watts per foot (80 watts per roll)
Light Output Per Roll	W: 1800lm, R: 1300lm, G: 1500lm, BL: 900lm, AM: 850lm
Package	16.25 feet per roll (5 meters)

LED Controller

Ref. Name: FL-RGB-CONT

This LED Controller, with reference name FL-RGB-CONT, is an economic mini-wireless controller for RGB LED lights. It is compatible with all RGB light fittings which demand for 12V DC input voltage. Its small size allows perfect designing ideas triggered by designers, architects and project undertakers for achieving various color changing patterns. With an easy-to-mount operation, our LED Controller even helps your LED lighting products controllable by people at bedrooms, kitchens, offices, and gyms. No more professional technicians! No more know-how manuals.

With FL-RGB-CONT you easily get the following color patterns:

1. Static Red, 2. Static Yellow, 3. Static Blue, 4. Static Cyan, 5. Static Green
6. Static Purple, 7. Static White, 8. Jumpy Changing, 9. Gradual Changing

Dimensions: 3.94 x 2.58 inches



LED Dimmable Controller

Ref. Name: FL-RGB-CONT-DIM

Product Discription

Working Temperature:	-20-60 celsius degrees
Input Voltage:	DC 12V
Dimensions:	4.13 x 2.95 x 1.14 inches
Output:	Three COMS output
Connecting Mode:	Common anode
Rated Current:	4A for each channel
Max Current:	6A for each channel



RGB Amplifier

Ref. Name: RGBA00

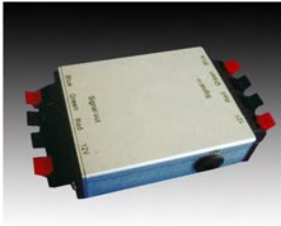

Connecting Mode:	Common anode
In/output Voltage:	DC12V
Recommended Current:	4A for each color
Max. Current:	6A for each color
Working Temperature:	-20°C-60°C
Dimensions:	3.66 x 2.56 x 0.94 inches

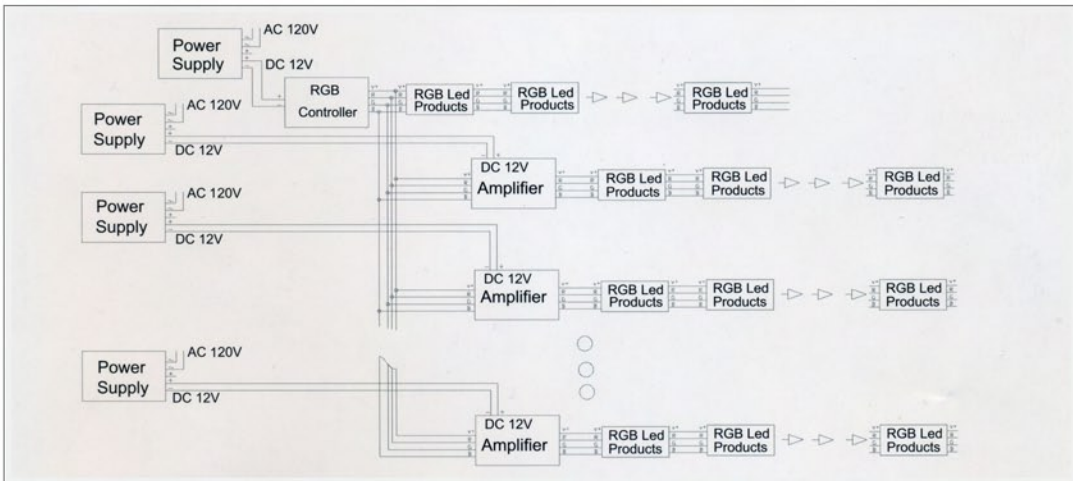
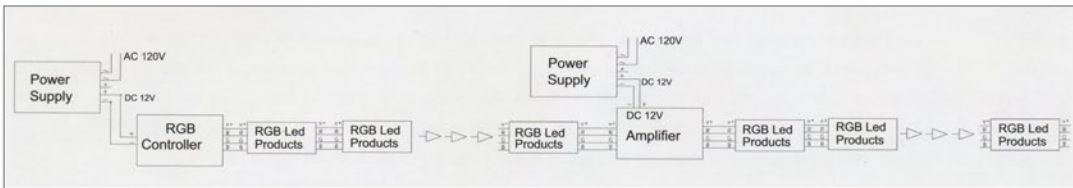
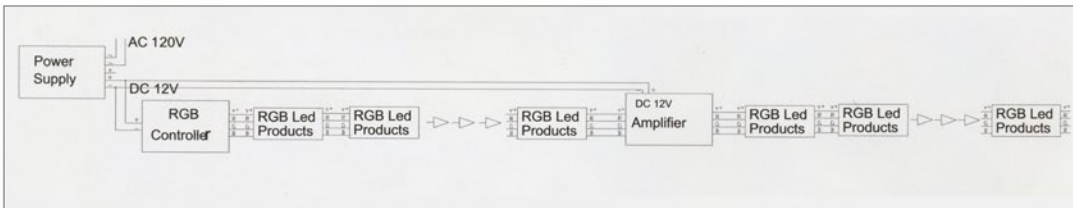

LED-10W 12V DC



LED-10W 12V DC
Dimensions: 1.1" x 1.38" x 3.43"
Load: 1-10VA
Input: 120-240V
Output: 12V DC

LED-25W 12V DC



LED-25W 12V DC
Dimensions: 1.2" x 1.57" x 5.24"
Load: 1-25VA
Input: 100V-277V
Output: 12V DC

LED-60W 12V DC



LED-60W 12V DC
Dimensions: 7.8" x 1.73" x 1.57"
Load: 1-60VA
Input: 100-277V
Output: 12V DC

LED-100W 12V DC



LED-100W 12V DC
Dimensions: 9.06" x 2.56" x 1.65"
Load: 1-100VA
Input: 100-277V
Output: 12V DC

FL-60W-LED-DIM



FL-60W LED DIM (Dimmable)
Dimensions: 7" x 3" x 4"
Load: 1-60VA
Input: 120-240-277V
Output: 12V DC
Can be dimmed with standard household dimmer

FL-60W-LED-12V DC



FL-60W LED 12V DC
Dimensions: 4.5" x 1.87" x 1.12"
Load: 60W
Input: 120 - 240V
Output: 12V DC
Cord and Plug

FL-98W-LED-12V DC

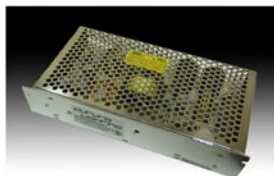

FL-98W LED 12V DC
Dimensions: 7.25" x 3.87" x 1.5"
Load: 98W
Input: 120 - 240V
Output: 12V DC
Cord and Plug

FL-240W-LED-DIM



FL-240W LED DIM (Dimmable)
Dimensions: 8.74" x 5.99" x 2.61"
Load: 240W
Input: 120V
Output: 4 x 60W 12V DC
Can be dimmed with standard household dimmer

FUTURA LIGHTING INC.
3305 SW 11TH AVE, FORT LAUDERDALE, FL 33315 UNITED STATES
PHONE: +1 (954) 523 8400, FAX: +1 (954) 523 8600
E-Mail: admin@futralighting.com

www.futralighting.com